

NEWDOSE D Series

Electromagnetic Driven Metering Pump

Operating Instructions

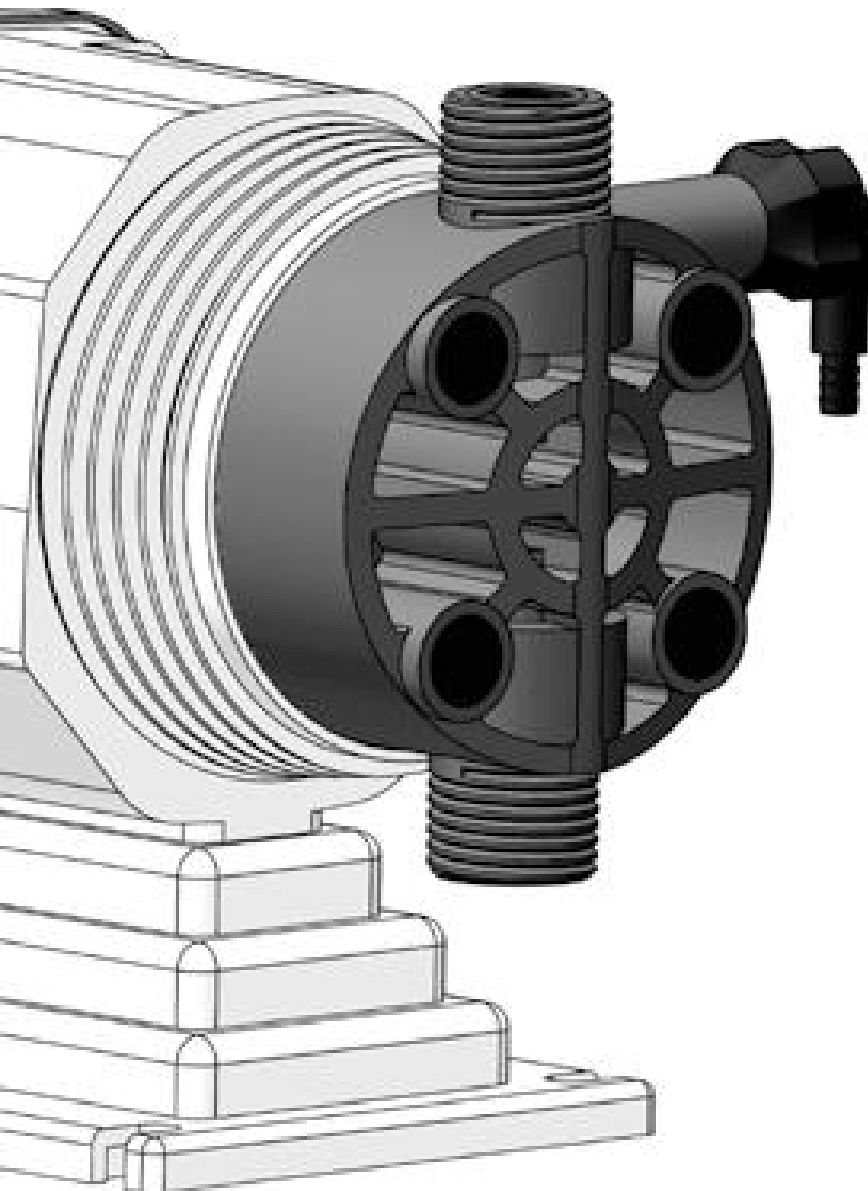

Table of contents

1. Overview

1.1 Warning	1
1.2 The storage	1
1.3 Usage instructions	1
1.4 Unpacking and Safety Information	1
1.5 Measurement of toxic or hazardous liquids	2
1.6 Assembly and disassembly of metering pump	2

2. D series dosing pump introduction—DFD/DP/DM/DC

2.1 Working principle	3
2.2 Specification introduction and models	3
2.3 Material parameter tables	6
2.4 Dimension Drawings	6
2.5 Installation	7
— Location and Methods	
— Electrical Wiring	
— Connecting Signal Lines	
— Control Wiring	
— Pipeline Connection	
— Liquid Suction	
— Operation Warning	
— Inspection and Maintenance	
— Flow regulation and calibration	

3. Commissioning of D series electromagnetic metering pump

3.1 DFD series— manual adjustment	14
3.2 DP series— pulse signal	14
3.3 DM series— 4-20mA signal	16
3.4 DC series— RS485 communication protocol	18

4. Maintenance

5. Common troubleshooting and treatment methods

Important Statements

- ★ This operating instruction must be carefully read before installation and use.
- ★ The installation of pumps and electrical equipment must follow the standards and specifications of the country where they are located.
- ★ Good grounding must be done during installation and using.
- ★ If the pump fails or is damaged, it must be repaired by authorized personnel and original accessories must be used, otherwise it will affect the safe use of the pump.
- ★ The maintenance of the metering pump ' s internal structure must be carried out by personnel with professional qualifications and authorized by the manufacturer. Therefore, all responsibilities arising therefrom shall be borne by the user.
- ★ Before carrying out maintenance or cleaning operations, the pump must use protective equipment, turn off the pump switch, and disconnect the pump power supply from the main power supply.
- ★ Avoid using pumps where the ambient temperature exceeds - 10~45°C or where pumps and pipes are directly exposed to sunlight.
- ★ Do not use metering pump in an environment outside the power supply range specified on the nameplate, otherwise it will cause damage to the pump or cause fire.
- ★ It is forbidden to pull, damage, or change wires, which may cause damage to the pump or cause fire.

Note: If there are any technical changes to this instruction manual, no further notice will be given.

1. Overview

Please read the relevant contents of this chapter carefully. It involves how to correctly install and safely use D series electromagnetic diaphragm metering pumps.

When designing the metering pump structure, we fully considered the occasions where it might be used. However, if it can be used correctly and with normal maintenance, the reliability and service life of its electrical and mechanical components can be correspondingly improved.

1.1 Warnings

Only professionals or manufacturers authorized personnel can inspect or repair the internal components of the metering pump. Damage caused by improper operation of other personnel is not within the scope of responsibility of the manufacturers.

Warranty period: the warranty period is one year, and damages caused by abnormal operation are not covered by warranty maintenance.

1.2 Storage and transportation of metering pump

The metering pumps must be placed horizontally during storage and transportation.

1.3 Usage of metering pump

The metering pump can only be used to measure and design selected liquids. Other liquids may not match the material of the metering pump. Measuring unidentified liquids may be dangerous and may damage the metering pump or hurt the operator. If the user is not particularly clear about the characteristics of the liquid to be measured, he can contact the manufacturer to assist in the type selection. The manufacturer shall not be liable for damages caused by abnormal use.

1.4 Unpacking and Safety Information

⚠ After opening the package of metering pump, check whether the metering pump is in good condition (as shown in figure 1). If any abnormal situation is found, please do not use it and inform the manufacturer of the relevant situation. Please put the removed packaging materials away from children to prevent them from eating by mistake.

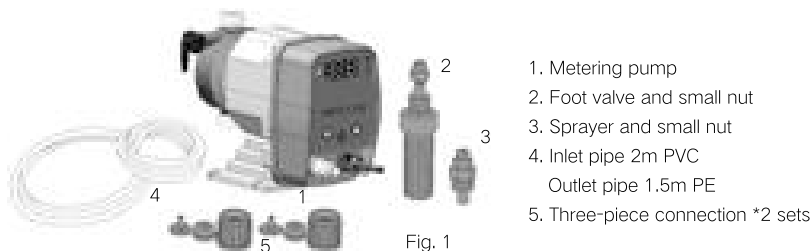

Fig. 1

- ⚠ Confirm that the local power supply parameters are consistent with those on the nameplate of the metering pump during electrical connection.
- ⊘ Do not start the metering pump without connecting the upper and lower pipe connectors, otherwise it may cause the upper and lower valves of the metering pump to lose parts.
- ⊘ The electrical installation shall conform to the local electrical installation standards. In addition, the following common sense shall be observed:
 - Do not touch the metering pump with wet hands or feet!
 - Do not operate the metering pump barefoot!
 - Under the condition of no guidance, children or people who are not familiar with the metering pump should not operate the metering pump without authorization!
- ⚠ If there is a sudden problem with the metering pump at work, please cut off the power supply immediately. Please do not repair the metering pump by yourself until you get help from the manufacturer's technicians.
- ⚠ If the metering pump is not used for a long time, please circulate clear water with the metering pump for 10-20 minutes and cut off the power supply and put it in a cool and dry place.

1.5 Measurement of toxic or hazardous liquids

- ⚠ If the metering pump is measuring toxic or dangerous liquids, please follow the following regulations:
 - Comply with all specifications formulated by the liquid manufacturer for liquid operation;
 - Ensure adequate ventilation of the operation site;
 - Ensure that all pressure parts of metering pump are in good condition before use;
 - Correctly select the material of the liquid contact parts, such as hoses, inlet and outlet valves, sealing rings, etc.
 - Before disassembling the metering pump, the pressure of the discharge pipe must be released, and the residual liquid in the metering pump must be neutralized or flushed with the relevant liquid.

1.6 Assembly and disassembly of metering pump

- ⚠ The metering pump is manufactured only after the whole assembly is completed that delivered to user, and no other assembly work is required.
 - For metering pumps that need to be disassembled for maintenance, the following preparations should be done before disassembling:
 1. Cut off the power supply of metering pump
 2. Remove the pipeline connected to the pump head of the metering pump (relieve the pressure of the pipeline before removing the pipeline)

3. Drain the residual liquid from the pump head of the metering pump (the metering pump is inverted or the pump head is removed)
- After the above steps are completed, the qualified personnel or electrical technician will carry out the repair work.
- ⊘ Disassembly of the metering pump by personnel not authorized by the manufacturer will cause irreversible damage to the metering pump and even cause liquid intake, leakage and even danger.

2. Introduction of D series metering pumps

2.1 Working principle of D series metering pump

The electromagnetic push rod of the electromagnet is provided with a PTFE diaphragm. When the electromagnet is energized, the electromagnetic push rod pushes the PTFE diaphragm to discharge the liquid in the pump head of the metering pump out of the metering pump through the outlet valve. Then the electromagnet is cut off. The electromagnetic push rod and PTFE diaphragm return under the action of the spring. The liquid is sucked into the metering pump through the inlet valve of the metering pump to complete a working cycle.

When the specifications of the metering pump remain the same, the volume of liquid measured in each stroke will remain the same, so the flow rate of the metering pump can be adjusted by adjusting the stroke frequency of the metering pump. The flow rate of metering pumps of D series can be adjusted by the Δ ∇ (up and down) button on the panel to achieve 0-100 % flow rate adjustment.

The actual flow rate of the metering pump will change due to the different back pressure of the external pipeline. The user can roughly calculate the current flow rate of the metering pump according to the pressure flow curve of the metering pump. If the metering is accurate, the user must calibrate the flow rate of the metering pump according to the actual working condition.

2.2 Specifications introduction and models

Brief introduction of pump:

- IP55 protection level
- Anticorrosive plastic casing
- Standard power supply 220VAC, 50Hz

Function Introduction and Models Selection:

In order to meet the requirements of different operating conditions, there are four models with different functions. DFD is manual flow control, DP can accept external control pulse signals, DM can accept standard external control signals 0-20mA/4-20mA, and DC can

accept external control RS485 signals (free communication protocol, non-Modbus and Profibus).

Please see the below sheet:

Model Code

CODE		SAMPLE					
		DFD	02	07	M	PPV	A
Control mode	DFD --- manual adjustment of stroke frequency						
	DM --- external control current signal controls stroke frequency						
	DP ---external control pulse signal controls stroke frequency						
	DC ---RS485 communication protocol adjusts stroke frequency						
Flow Rate							
Pressure							
Model	M/HX/NX/GX/LM/X						
Pump Head		Pump head	Diaphragm	Valve seat	Valve ball	Sealing ring	
Material	PPV ---- PP	PTFE	PTFE	Ceramics	FKM		
	PVT ---- PVC	PTFE	PTFE	Ceramics	FKM		
	SST ---- SS316	PTFE	SS316	SS316	FKM		
	PTF ---- PTFE	PTFE	PTFE	Ceramics	---		
Power Type	A ----- 230V 50Hz	230V 50Hz	Power cord1.5m				
	B ----- 115V 50Hz	115V 50Hz	Power cord1.5m				
	C -----	If there are special requirements, it shall be noted separately.					

Example:

The maximum lift is 7kg, displacement is 12L/h, 230V 50hz, PVC pump head is required, and current signal controls stroke frequency, the selection is as follows:

DM-12-07-LM-PVT-A

Note: due to the limitation of processing equipment characteristics, the maximum flow rate of metering pump and the flow rate indicated in the model stable may produce deviation of less than 5 %. Please take it into consideration when selecting the model.

Parameter Table

Series	Model	Capacity	Pressure	Working Frequency	Power	Weight	Size
		L/h	Bar	times/min	W	Kg	
DFD - M	01-07-M	1	7	120	30	2.4	A
	02-07-M	2	7	120	30	2.4	A
	03-07-M	3	7	120	30	2.4	A
	06-05-M	6	5	180	40	2.4	A
	09-03-M	9	3	180	40	2.4	A
DFD - NX	09-07-NX	9	7	160	40	3.2	B
	12-07-NX	12	7	160	40	3.2	B
	15-04-NX	15	4	200	40	3.2	B
	20-03-NX	20	3	200	40	3.2	B
	25-02-NX	25	2	200	40	3.2	B
DFD - HX	02-20-HX	2	20	180	40	2.4	A
	05-12-HX	5	12	180	40	2.4	A
	06-07-HX	6	7	180	40	2.4	A
	10-05-HX	10	5	200	40	2.4	A
DFD/DP/ DM - GX	06-16-GX	6	16	200	60	3.8	C
	23-05-GX	23	5	200	60	3.8	C
	33-03-GX	33	3	200	60	3.8	C
	55-0.1-GX	55	0.1	240	60	3.8	C
DP/DM/ DC - LM	01-07-LM	1	7	120	30	3.2	B
	02-07-LM	2	7	120	30	3.2	B
	03-07-LM	3	7	120	30	3.2	B
	06-05-LM	6	5	180	40	3.2	B
	09-03-LM	9	3	180	40	3.2	B
DP/DM/ DC - X	02-16-X	2	16	120	65	3.8	C
	06-07-X	6	7	120	65	3.8	C
	09-07-X	9	7	120	65	3.8	C
	12-07-X	12	7	120	65	3.8	C
	15-03-X	15	3	120	65	3.8	C
	20-03-X	15	3	160	65	3.8	C
	30-03-X	30	3	160	65	4.2	D
	50-02-X	50	2	160	65	4.2	D

2.3 Material Table

Material of Accessory Kit				
	Standard	Optional material		
		PTFE	PU	UPVC Hard Tube
Inlet Pipe	PVC	PTFE	PU	/
Outlet Pipe	PE	PTFE	PU	/
Three-piece connection	PVC	PTFE	PVC	/
Big nut	PVC	PTFE	PVC	PVC
Foot valve	PP(FRPP)	/	PP(FRPP)	/
Sprayer	PP(FRPP)	/	PP(FRPP)	/
Small nut	PP(FRPP)	/	PP(FRPP)	/
Hard Pipe Connectors	/	/	/	PVC

Adjustable back pressure valve	Nonadjustable back pressure valve	External thread connector
PVC	PVC	PP/PVC/PTFE

2.4 Dimension Drawings

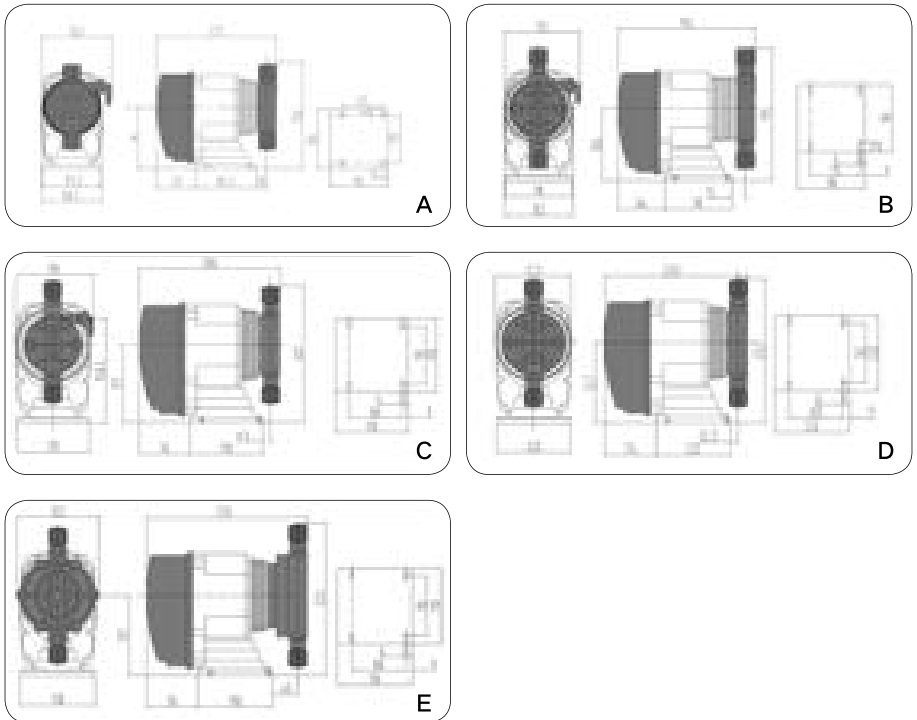



2.5 Installation

Location and Methods

Location: the place where the metering pump is installed should be dry, far away from the heat source, and the ambient temperature should not exceed 0-40°C ;

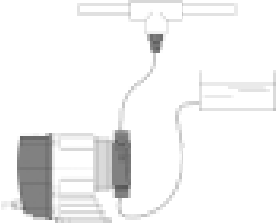
Installation methods: when installing metering pump, the following situations will usually be encountered:

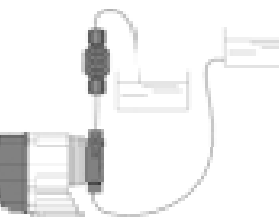
<p>A</p>	<p>The installation position of the metering pump is lower than the liquid level in the dosing box, and the position of the dosing point is higher than the liquid level in the dosing box: this is an ideal installation mode. In this case, the liquid can flow directly to the pump head of the metering pump, emptying the air in the metering pump, and the metering pump can be started easily. This installation method is recommended for liquids that easily generate bubbles, such as sodium hypochlorite and hydrogen peroxide, or liquids with high viscosity.</p>	 <p style="text-align: right;">Fig.2</p>
<p>B</p>	<p>The installation position of the metering pump is higher than the liquid level in the dosing cabinet, but lower than the position of the dosing point: For this installation method, attention should be paid to the height difference between the pump head and liquid level of the metering pump. This value is related to the suction distance of the metering pump. The suction distance of the DFD, DP, DM and DC series metering pumps are 2m. If the height difference between the pump head and the liquid medicine is greater than 2m, the metering pump will not work normally. Therefore, when installing the metering pump, the height difference between the two should be shortened as far as possible. In addition, if the standard hose configured by the metering pump is not selected, the thinner suction line should be used as far as possible, which is beneficial to the starting of the metering pump.</p>	 <p style="text-align: right;">Fig.3</p>
<p>C</p>	<p>The liquid level in the tank is higher than that of the dosing point: when the metering pump is installed in such a situation, siphon phenomenon will occur between the dosing tank and the dosing point. even if the metering pump stops working, the liquid will flow directly from the dosing tank to the dosing point. If this happens, there are two solutions: ① Install a backpressure valve on the outlet line of the metering pump to adjust the magnitude of backpressure until the above situation does not occur (as shown in figure 3). ② Destroying siphon: install exhaust valves or set aside exhaust holes at the highest point of the system pipeline.</p>	 <p style="text-align: right;">Fig.4</p>

- ⚠ Note: avoid sharp bends and knots in the inlet and outlet pipes, and do not make the pipes be scratched or cut off by sharp edges and corners.
- ⚠ The screw thread specification at the one-way valve of the D series electromagnetic diaphragm metering pump is 1/2G" straight pipe thread. Even if the raw material belt is wrapped, leakage will occur with the passage of time. If the liquid is highly corrosive, it will have a greater impact on the metering pump.
- ⊘ It is strictly prohibited to directly connect with the 1/2G" internal thread connector after wrapping the raw material tape at the pump head inlet and outlet. Our company has the right not to guarantee the quality of this metering pump when it breaks the valve box body and enters the liquid during use.

If PVC hard pipe linked metering pump must be used under working conditions, special "hard pipe connectors" (see figure 5) for electromagnetic pump can be selected to directly connect with DN15 (15 mm inner diameter) PVC hard pipe without additional pipe fittings.

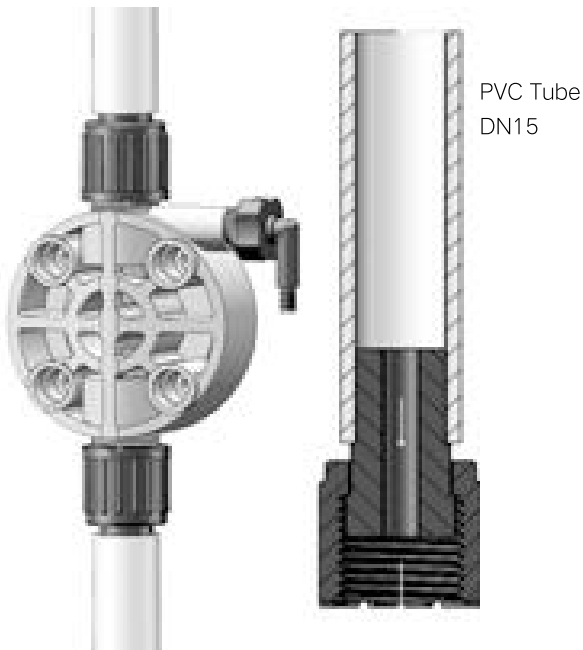

Fig.5

Electrical Wiring

The electromagnetic diaphragm metering pump is equipped with a 2m random cable, which can be extended by the user or supplied by the manufacturer. The cable color is shown in figure 6. During electrical installation, an air switch should be installed between the pump and the power supply and conform to the local electrical installation specifications.

Note: make sure that the power supply circuit is disconnected during wiring.

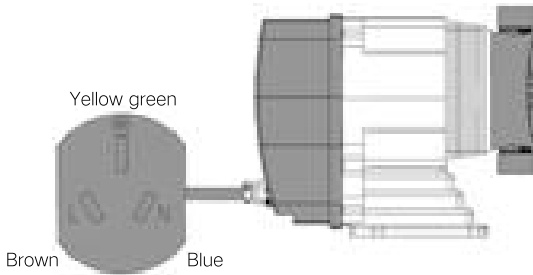

Fig.6

Connecting Signal Lines

Please refer to the following figure 7 and 8 for wiring and note that there are corresponding terminal numbers under the wire terminals.

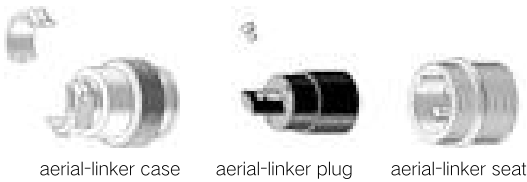



Fig.7





Fig.8

Control Wiring:

Incorrect wiring will cause irreversible damage to the metering pump. Please read the following carefully:

<p>DFD</p>	<p>The interface of DFD metering pump only has a remote-control interface. Remote control interface: the signal is the switch signal of the dry node, normally on or off control. (figure 9)</p>	 <p>Fig.9</p>
------------	--	--

<p>DP</p>	<p>DP metering pump has two interfaces: Remote control interface and pulse control interface. Remote control interface: interface signal is switch signal of dry node, normally on or off control ; Pulse control interface: interface signal is pulse signal or passive switch signal. The generated pulse signal voltage cannot exceed 24v. The metering pump automatically adjusts the output flow rate of the metering pump according to the change of the external pulse signal (as shown in figure 10).</p>	 <p>Fig.10</p>
<p>DM</p>	<p>There are two interfaces of DM metering pump: remote control interface and current control interface. Remote control interface: the interface signal is the switch signal of the dry node, and the normally on or off control. Current control interface: the interface signal is the standard current signal 0/4-20mA, and the metering pump automatically adjusts the output flow of the metering pump according to the change of the external current signal. The control mode is proportional control, and the proportional coefficient can be adjusted to realize frequency division and frequency multiplication. (figure 11)</p>	 <p>Fig.11</p>
<p>DC</p>	<p>There are two interfaces of DC metering pump: remote control interface and 485 control interfaces Remote control interface: the interface signal is the switch signal of the dry node, and the normally on or off control. 485 control interfaces: the metering pump automatically adjusts the output flow of the metering pump according to the changes of external 485 signals (free communication protocol, non-Modbus and Profibus). (figure 12)</p>	 <p>Fig.12</p>

⊗ It is strictly prohibited to connect the positive and negative signal lines in reverse. Connecting the signal lines in reverse will cause damage to the circuit board or damage to the entire pump. The company has the right not to guarantee the metering pump caused by the reverse connection of signal lines.

Pipeline Connection

⚠ Standard accessories kit includes: 2 meters PVC transparent liquid inlet hose, 1.5 meters PE translucent liquid outlet hose, filter (PP) and sprayer (PP).

Connection method: one end of the inlet pipe is connected with the filter and the other end is connected with the inlet check valve of the metering pump; One end of the liquid outlet pipe is connected with the outlet check valve of the metering pump and the other end is connected with the sprayer. The thread of sprayer is 1/2G" (4 scruples), which can be directly screwed into other pipe valve parts by wrapping the raw material tape. (figure 13,14)

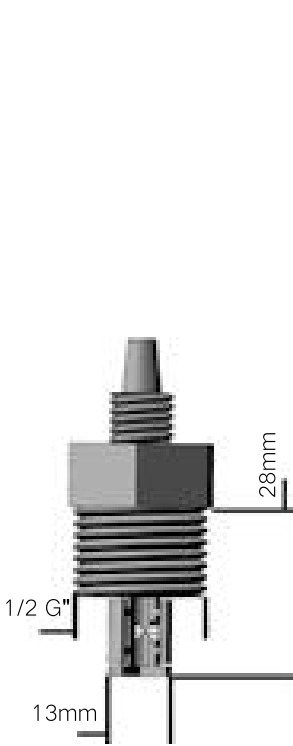

Fig.13



Fig.14

⚠ Liquid Suction

Install the metering pump according to the above requirements and start it. Firstly, unscrew the exhaust valve by half a turn, the liquid will be suction into the pump head very quickly. Then close the exhaust valve after the liquid starts to discharge from the exhaust valve so as to confirm the pump head is filled with liquid and could deliver liquid normally.

⚠ Operation Warning

- ⊘ Do not allow the pump to run with the outlet line completely closed. Otherwise, it may cause liquid leakage or pipe rupture. Therefore, please ensure that the valve of the outlet pipeline is fully opened before opening the metering pump.
- ⊘ Do not allow the metering pump working without liquids for a long time. Although idling the pump will not cause damage to the diaphragm or burn the pump, repeated or prolonged idling will cause the temperature of the metering pump to rise, accelerating the aging of electrical components and electromagnets and reducing the service life of the metering pump.

⚠ Inspection and Maintenance

- Install a section of pipe on the exhaust valve to return the chemical tank or other collecting container.
- Check and clean the check valves and foot valve regularly to ensure that there are no impurities in the liquid contact parts.
- Check and tighten the bolts of pump head regularly to keep its firmly connected with pump body. If the pump head connecting bolt is loose, the pump head will be easy get leakage and decrease the flow rate.
- ▶ Recommended regular inspection time: continuous operation for 500 hours or cumulative operation for 1000 hours.
- ▶ Bolt pre-tightening torque:
 - M/HX: 2.16N.m
 - NX/GX/X: 2.41N.m
 - 30/50L: 2.90N.m

⚠ Flow regulation and calibration

The nameplate data and specifications on the pump are measured by clean water at normal temperature, the actual capacity will vary depending on different conditions, such as actual different pipelines and liquids. If it is necessary to adjust or calibrate the flow rate of the metering pump by itself, the metering pump shall be calibrated on site.

Calibration method:

- ① Place the foot valve in a container with scale and have a sufficient amount of clean water.
- ② Start the pump, unscrew the exhaust valve and discharge air bubbles, tighten the screw, and stop the pump.
Write down scale A (mL) at this time

③ Start the pump and start the timing to calculate a certain time T (min) (it is recommended not to be less than 5 min).

Write down scale B (mL) at this time.

④ The flow rate by this moment $V = \frac{B-A}{T} \times 60$ (L/H)

⑤ Write down the current number displayed on the metering pump panel, N_1

⑥ The actual required flow rate is G (L/H).

⑦ The actual frequency number that the metering pump needs to adjust the panel is

$$N_2 = \frac{GN_1}{V} \text{ (stroke frequency).}$$

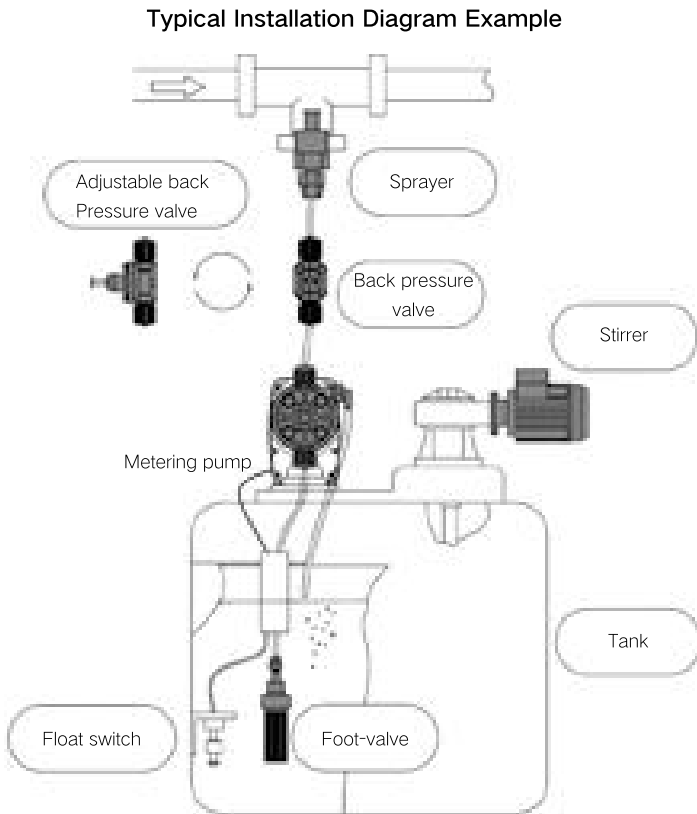

Fig. 15

3. Commissioning of electromagnetic metering pump

3.1 Operation and commissioning of DFD series

Control Elements Overview—DFD series

- ① Remote control interface
(some models do not have this interface)
- ② Power cord connector
- ③ Power cord connector
- ④ Pump work indicator
- ⑤ Frequency numbers decrease button
- ⑥ Start/Stop
- ⑦ Frequency numbers increase button

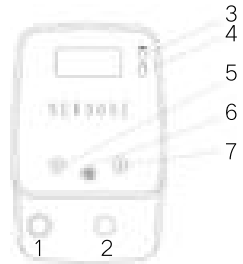

Fig. 16

Commissioning of DFD series —manual type

- Turn on the power supply to the metering pump according to the specifications. At this time, the power indicator lights up and the on/ off key is pressed. Then the metering pump starts to work. The working frequency is the panel display frequency.
- Press the up or down key to adjust the output flow rate of the metering pump to the required flow rate.
- Working flow calculation: divide the maximum flow rate of metering pump by its max frequency numbers, then plus the current working frequency. For example, if the current operating frequency of a metering pump with a flow rate of 3L/H at 7 Bar is 80 strokes/min, its max working frequency numbers is 120 strokes per min, then the current flow rate is $3/120 \times 80 = 2L/H$. In turn, you could get the frequency numbers to match the flow rate you need in this way.

3.2 Operation and commissioning of DP series

Control Elements Overview—DP series

- ① Pulse signal control interfaces
- ② Power cord connector
- ③ Remote control interface
- ④ Power indicator
- ⑤ Pump work indicator
- ⑥ Frequency numbers decrease key
- ⑦ Frequency numbers increase button
- ⑧ Start/Stop
- ⑨ Manual or automatic switch key
- ⑩ Function key

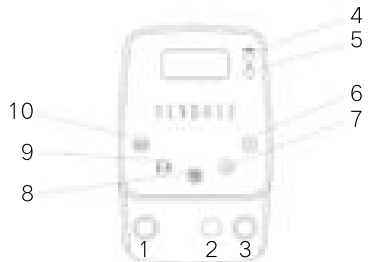

Fig. 17

Commissioning of DP series—Pulse signal control

- Switch on the power supply to the metering pump according to the specifications. At this time, the power indicator lights up and the A /M key are pressed to switch the operation mode of the metering pump: manual adjustment and pulse signal control. Note that the working mode can only be switched when the metering pump is stopped.
- When the metering pump works in manual mode, press the on/off key, and the metering pump starts to work. The working frequency is the panel display frequency, and then the red indicator light flashes. The flashing frequency is the current working frequency of the metering pump.
- When the metering pump is working in the pulse signal adjusting state, press the on/ off key, and the metering pump starts to work. The metering pump automatically adjusts the flow output according to the pulse frequency. The working frequency is the panel display frequency. The red indicator light flashes and the flashing frequency is the current working frequency of the metering pump.
- Switching steps of working mode:

operating mode switch of manual vs pulse signal				
operation	panel display	code	green light	Operational Status
/	___ H	H	flashing	the pump is being manual operation mode
press A/M button	___ P	P	flashing	the pump is being external pulse signal operation mode

- The manual parameter setting step can adjust the flow rate when the metering pump stops or runs:

setting step of manual operation mode				
operation	display	code	green light	Operational Status
/	___ H	H	flashing	the pump is being manual operation mode
press ▲ / ▼ button	___ H numbers change	H	flashing	the capacity will be increased or decreased
press start/stop	___ H	H	stop flashing	The pump is being operation state

- Setting steps for automatic parameters:

When the metering pump works in an automatic mode, the flow rate of the metering pump can be automatically adjusted according to the frequency of external pulses.

setting steps of automatic operation mode	
operation	display
press on/off button	___ P
press ADJ button longer	___ L
press ▲ key	___ L (modify the number of output pulses of metering pump)
press ADJ key	___ r
press ▲ key	___ r (modify the number of control pulses)
press ADJ key	___ P

- Setting steps of DP-LM or DP-NX series

The manual status panel displays _ _ . (there is a dot in lower right corner)

If the dot disappears, it is in the on state and if the decimal point appears, it is in the off state. Press A/M XXP If the P key flashes, the metering pump works in an external pulse control state

When the metering pump works in an automatic condition, the flow rate of the metering pump can be automatically adjusted according to the frequency of external pulses.

Setting step of DP-LM & DP-NX	
Operation	Panel display
Press on/off key	_ _ _P
Press ADJ key longer	- · _ _
Press ▲ key	_ · _ _ (modify the number of output pulses of metering pump)
Press ADJ key	_ _ · _
Press ▲ key	_ _ · _ ▯ (modify the number of control pulses)
Press ADJ key	_ _ _P

3.3 Operation and commissioning of DM series

Control Elements Overview—DM series

- ① current control interfaces
- ② Power cord connector
- ③ Remote control interface
- ④ Power indicator
- ⑤ Pump work indicator
- ⑥ Frequency numbers decrease button
- ⑦ Frequency numbers increase button
- ⑧ Start/Stop
- ⑨ Manual or automatic switch key
- ⑩ Function key

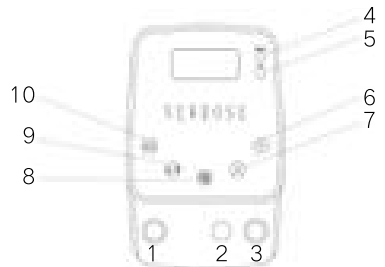

Fig. 18

Commissioning of DM series — Current signal 0/4-20mA

- Switch on the power supply to the metering pump according to the specifications. At this time, the power indicator is on. Press the A/M key to switch the working mode of the metering pump: manual control and 0/4 - 20mA current signal control.

When the metering pump works in the manual state, for example, the display number is 120F, i.e. the pump is stopped in the manual state. Press the start / stop key and the metering pump will start to work. The working frequency is the panel display frequency. The red indicator light flashes and the flashing frequency is the current working frequency of the metering pump.

When the metering pump works in an automatic state, the panel displays 000A. When A flashes, the metering pump is in stop state and the panel does not flash the working

state of the metering pump. Press the start / stop key to start the metering pump. The metering pump automatically adjusts the flow output according to the magnitude of the external control current. The operating frequency is the panel display frequency. The red indicator light flashes, and the flashing frequency is the current working frequency of the metering pump.

- Setting step of manual operation mode

operation	display	code	green light	Operational Status
/	___F	F	flashing	the pump is being manual operation mode
press ▲ / ▼ button	___F numbers change	F	flashing	the current operating frequency numbers changes, so the capacity will be increased or decreased
press start/stop	___F	F	stop flashing	The pump is being operation state

- Setting steps for automatic parameters:

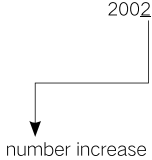
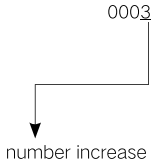
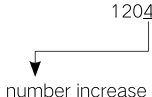
setting steps of DM series automatic operation mode		
Operation	Panel display	Operational Status
press A/M button	000A	the pump is being signal control mode
press ADJ for 5 seconds	0401 (1 flashing)	Modify parameter 1, which is the starting control current: when the external control input current is less than this parameter, the metering pump stops working.
Press ▲ or ▼ button	0401 number increase or decrease	
Press ADJ button	2002 The last number (2 flashing)	Modify parameter 2, which is the final control current: when the external control input current is greater than the starting control current and less than this parameter, the metering pump calculates the current operating frequency based on the magnitude of the external control current and automatically adjusts the metering pump.
Press ▲ or ▼ button	2002  number increase or decrease	
Press ADJ button	0003 (3 flashing)	Modify parameter 3, which is the starting control frequency: set the working frequency corresponding to the starting control current. When the starting control frequency is less than the final control frequency, the metering pump is controlled in a positive proportion, and when the starting control frequency is bigger than the final control frequency, the metering pump is controlled in a reverse proportion.
Press ▲ or ▼ button	0003  number increase or decrease	
Press ADJ button	1204 (4 flashing)	Modify parameter 4, which is the final control frequency: set the operating frequency corresponding to the starting control current.
Press ▲ or ▼ button	1204  number increase or decrease	
Press ADJ button to exit	000A	the pump is being automatic controlled by 4-20mA signal

3.4 Operation and commissioning of DM series

Control Elements Overview—DM series

- ① 485 control interfaces
- ② power line interface
- ③ Remote control interface
- ④ Power : power indicator
- ⑤ pump work indicator
- ⑥ Frequency numbers decrease button
- ⑦ Frequency numbers increase button
- ⑧ Start/Stop
- ⑨ Frequency numbers increase button



Fig. 19

Commissioning of DC series —RS485 communication protocol

- Turn on the power supply to the metering pump according to the specifications. At this time, the power indicator lights up and the start / stop key is pressed. The metering pump starts to work. The working frequency is the panel display frequency. The red indicator light flashes and the flashing frequency is the current working frequency of the metering pump.
- DC series pumps apply RS485 communication, Modbus RTU protocol and CRC check are adopted. 8 data bits, 1 stop bit, no check bit, 9600 baud rates.
- Introduction of command operation

- ① Read the operation, function code is 03.

Set the pump's on and off store register address to 2, take 2 bytes

Set Pump frequency parameter address to 4, take 2 bytes.

Sample: When the address is 200

C8 03 00 01 00 01 C4 53 (read the pump's on/off state)

C8 03 00 03 00 01 65 93 (read pump's frequency number)

C8 03 00 01 00 02 84 52 (read pump's on/off state and frequency number)

- ② Preset the operational function code is 06 and 16. 06 means preset single register; 16 means preset multiple or single register.

Set the pump's on and off store register address to 2, take 2 bytes.

Set Pump frequency parameter address to 4, take 2 bytes.

Sample: When the address is 200

C8 06 00 01 00 01 08 53 (start the pump)

C8 06 00 01 00 00 C9 93 (stop the pump)

C8 06 00 03 00 48 68 65 (72 change the frequency number to 72)

C8 10 00 03 00 01 02 00 49 5D C0 (73 change the frequency number to 73)

C8 10 00 01 00 01 02 00 01 5C 14 (start the pump)

C8 10 00 01 00 01 02 00 00 9D D4 (stop the pump)

C8 10 00 01 00 02 04 00 00 00 48 E0 CA (stop the pump and change the

frequency number to 72)

C8 10 00 01 00 02 04 00 01 00 48 B1 0A (start the pump and change the frequency number to 73)

③ Broadcast Mode address is 00.

All the online pumps could receive signals (06 and 16).

4. Maintenance of metering pump

- Regularly check the liquid level in the chemical storage tank to prevent the metering pump from running without load.
- The metering pump will not damage when it is running under no load, but it will affect the system due to no dosing. A level switch can be installed to automatically disconnect the metering pump to prevent no-load operation when the liquid level is lower than the set level.
- Check at least once every six months whether the bolts of the pump head of the metering pump are tightened and whether all the seals are in good condition. If the liquid transported is corrosive, the number of inspections needs to be increased. In addition, attention should be paid to the following situations:
- Whether the indicators on the control panel work properly
- Whether the concentration of the added liquid in the system is normal. If the concentration decreases, check whether the check valve and filter are working properly and then clean or replace them.
- We suggest that users clean check valves and filters regularly. Because the media delivered are different, we have no way to give an accurate cleaning cycle. Users can make their own decisions according to the actual situation.

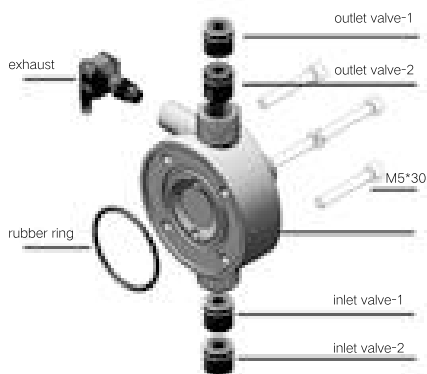

Fig. 20

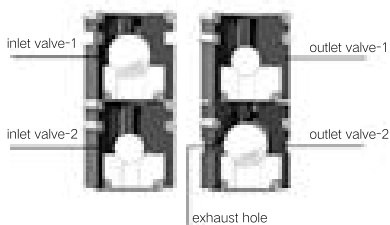

Fig. 21

5. Common faults and treatment methods

Fault	Possible causes	Correction method
pump cannot be displayed or started	wiring error	check and correct wiring
	wrong voltage	set the right voltage by nameplate
	circuit board fuse	replace the right safety tube
	circuit board damaged	replace the circuit board
pump cannot suck liquid	the liquid suction end is not sealed well	check whether the seals and quick links are in good condition
	wrong valve assembly	check and reassemble according to the instructions
	suction too high	reduce the installation height of the pump
	suction pipe blocked	open the exhaust valve to remove gas
	the liquid is too viscous or easily produces bubbles.	the installation position which is lower than the liquid level
	foot valve blocked	clean filter plate and bottom valve
unstable capacity	pump head blocked or impurities	clean pump head and components
	there are impurities body in pump head diaphragm damage	clean pump head and components replace diaphragm
lower capacity	impurities in pump head	clean pump head and components
	outlet pressure is too high	check nameplate and replace metering pump with higher pressure
	liquid viscosity is too high	please contact the manufacturer, change high viscosity check valves if necessary
	driven unit damaged(electromagnet)	return to factory for replacement
	circuit board damaged	replace the circuit board
larger capacity	siphon occurs	set a backpressure valve on to the liquid outlet pipe
	small outlet pressure	set a back pressure valve to the outlet pipe or change one smaller capacity pump
Liquid leakage	upper and lower valve nuts loose	tighten
	pump head become loose	tighten bolts M/HX: 2.16N.m NX/GX: 2.41N.m EX: 2.90N.m
	diaphragm damage	replace diaphragm
	missing seal	replace the seal
	seal parts or pump head is corroded	please contact the manufacturer
	the outside temperature or liquid temperature is too high	Please contact the manufacturer

Remarks :

- The voltage by the pulse signal should not be higher than 24V.
- Connect the plus or minus signal opposite is forbidden, or this will ruin the circuit board even the whole pump.
- If the pump is damaged by connecting the signal wire wrong, we won't take this into warranty.